

InsuSox[®] is flexible pre-insulated air duct system with perfect integration of fabric and thermal insulation material by utilizing exclusively patented composite technology. InsuSox[®], installed by cable suspension, serves as air delivery duct for various fields of HVAC industry and works with terminal air dispersion system as air vents, air damper & DurkeeSox[®] fabric air duct, replacing all kinds of on-site fabricated traditional ductwork.

BACKGROUND

With the improvement of living standard and wider application of A/C system, the requirement on reliability, installation, energy conservation and cost-efficiency of A/C components especially air ductwork becomes higher and higher.

Major ductworks in prevailing market are as following:

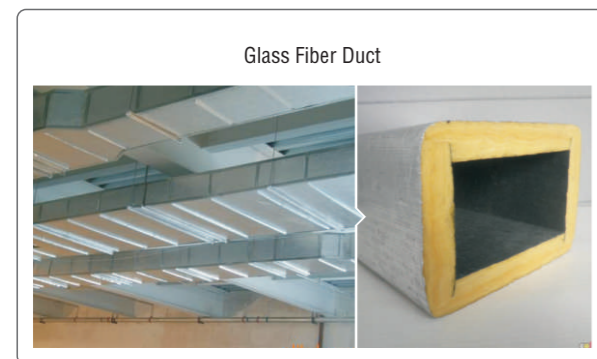
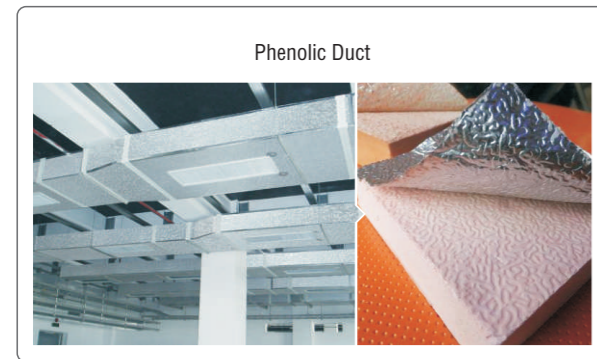

None of them in prevailing marketing is able to meet the performance requirement on air leakage, resistance, strength, condensation, fire resistance and noise control.

Common issues of all above mentioned air ductwork:

On-site work			
	Fabrication at job site leads to poor quality	Long installation time & high construction cost	Complicated installation/massive material wastage
System operation			
	Loud noise	High risks of condensation	Air leakage
Maintenance			
	Difficult to wash	High risks of breakage or damage	Difficult for maintenance
Green & Energy-saving			
	High resistance	large energy consumption	Material is not environment friendly and low carbon

Given all issues of traditional air ductwork, on-site fabrication and installation could not keep pace with current demand for high construction quality, quick & factory prefabrication, standardized, integrated and modularized on-site installation.

The mainstream of global air dispersion industry is to ease the on-site construction difficulty, reduce the operation procedure and cut the cost under the precondition that the basic properties of air duct such as service life and heating insulation performance are guaranteed.

PREFACE

At present, it has become an irresistible trend to develop a new type of air duct gifted with delivery as finished product, quick installation, light self-weight, excellent fire-safety, quiet operation, easy maintenance, healthy and green property. DurkeeSox[®] became the first one to propose a comprehensive solution to ensure the service life of air duct system while bring out the best heating insulation performance.

Insusox[®], served as composite air duct system solution, utilize special textile material as external surface and high performance heating insulation as interior composite layer, preserving the performance advantages of traditional duct like heating insulation, energy conservation, long lifespan, excellent fire safety while possessing absolute superiority like light self-weight, quick installation, delivery as finished product, low cost, quiet operation, easy maintenance, health and green property, etc.

With the integration and industrialization of product processing procedure in the factory, Insusox[®] eliminates the defects of on-site fabrication to ease on-site work difficulty, cut down the cost, shorten the construction time, reduce the weight and noise and improve the after-sale maintenance..

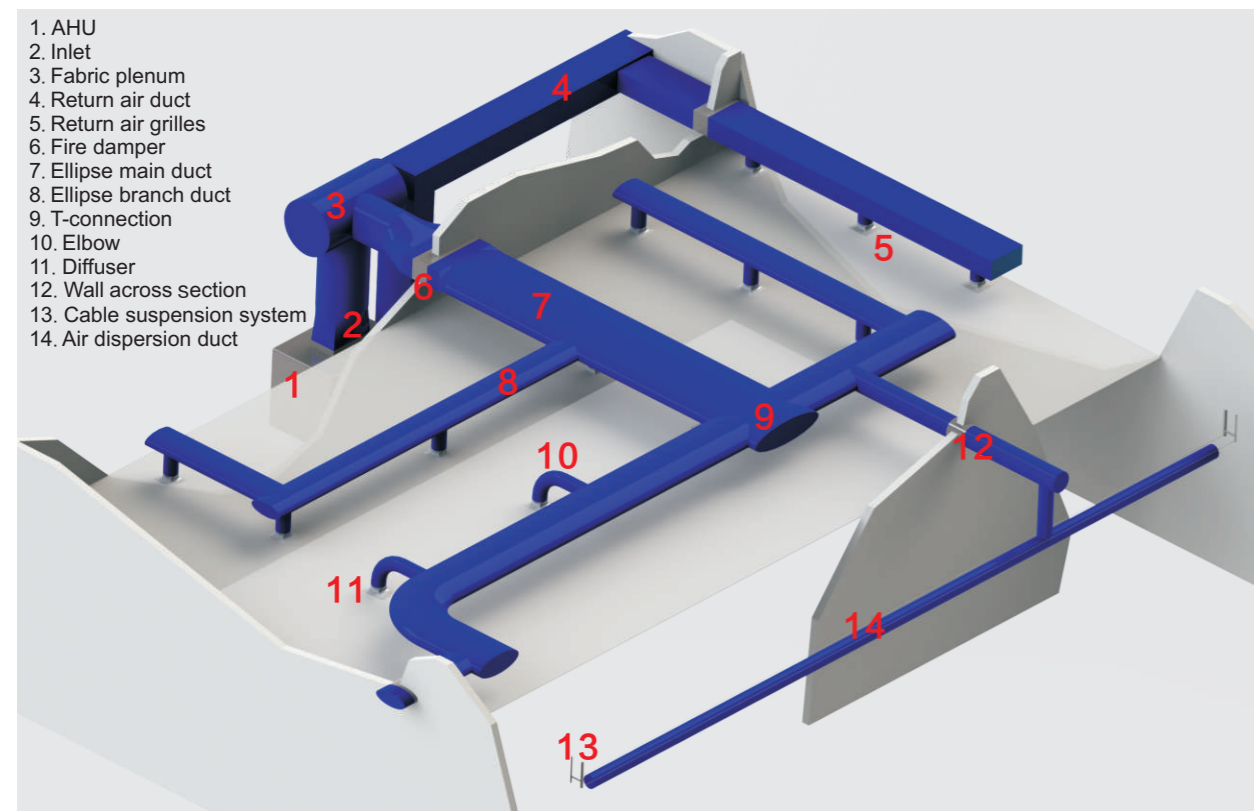

System diagram of Insusox[®] in facility with false ceiling

DEFINITION

Insusox[®] is a pre-insulated fabric air duct system with perfect integration of special fabric surface and high-performance thermal insulation material by utilizing exclusively patented composite technology. Different types of functional layers attached to internal duct face improve the overall performance of Insusox[®] air dispersion system and bring new technological revolution in ventilation system.



Diagram of Patented Multi-layer Composite Material

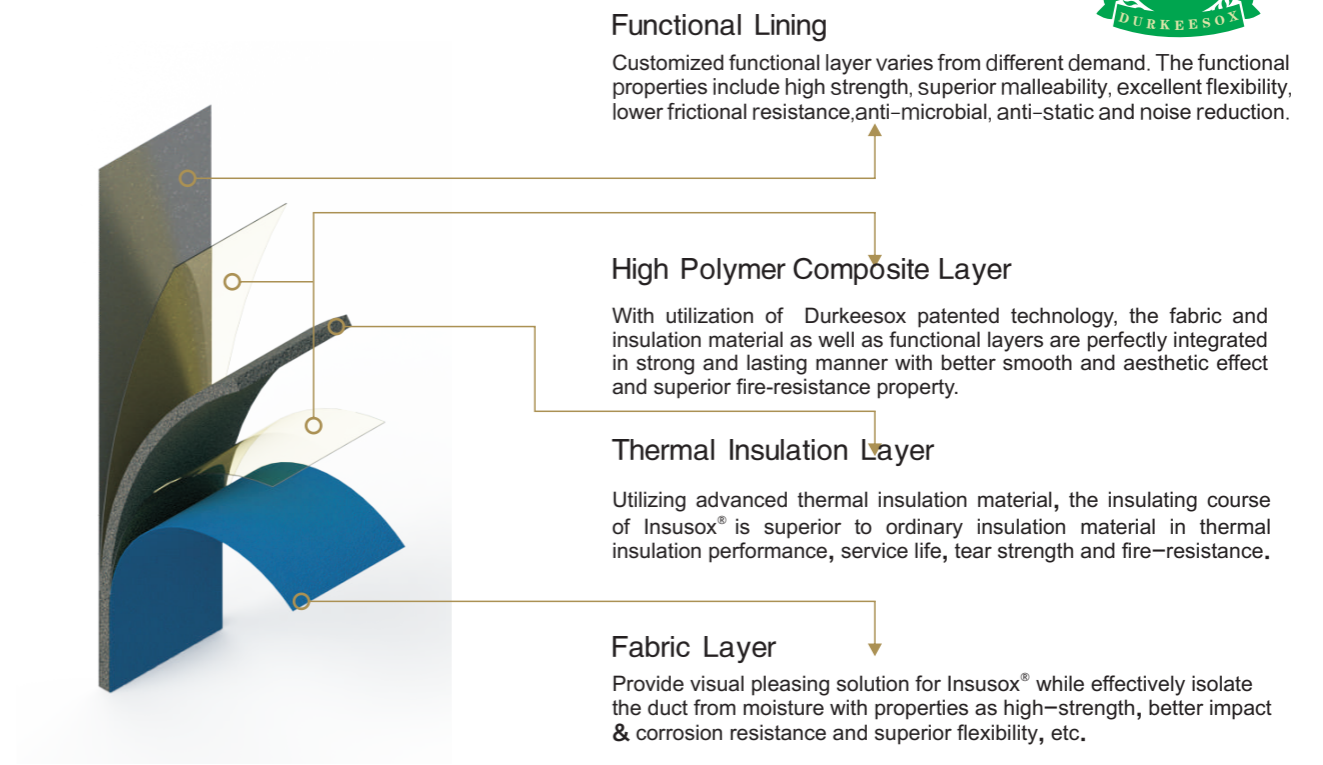

Insusox[®] Multi-layer Diagram

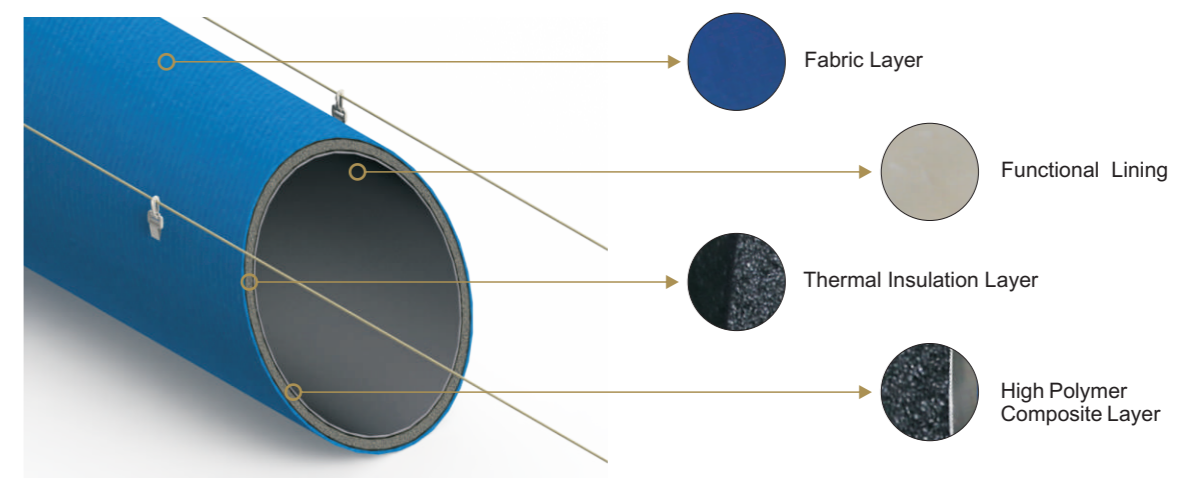

ADVANTAGE

Insusox® the versatile air dispersion system—superior in all-round performance

01 Fabricated with fire-retardant material, the fire safety is more reliable.



Fire safety

The thermal insulation layer is made of high quality thermal insulation material, resulting in lower heating conductivity coefficient. Integrated composite thermal insulation material with infinite moisture resistance factor presents better thermal insulation property.



Thermal Insulation Performance

Around 0.8-1.4kg/m², less than 1/15 of traditional duct, one time lighter than other type of composite duct, dramatically reducing heavy load of the building plus quick installation.



Lighter self-weight

With the realization of integration and streamline production in the factory, finished product is delivered to site and quickly installed by cables. The installation time is 1/10 less than traditional air duct without any on-site material wastage.



Quick Installation

05 The pressure resistance reaches 3000Pa.



Better pressure resistance property

Insusox® Duct System

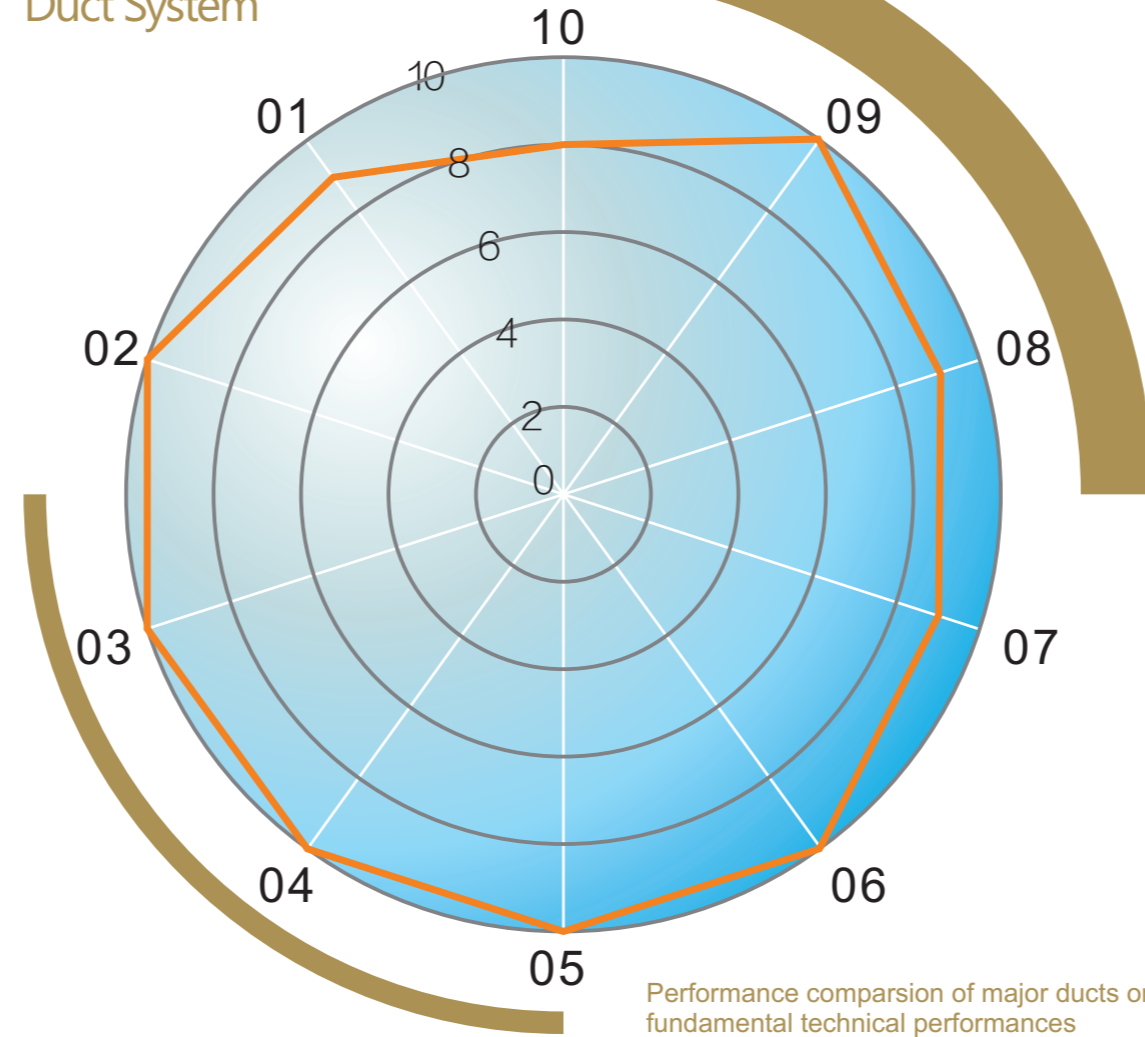

10 High cost-efficiency

Compared with traditional air duct, the layout design of Insusox® is simpler. Factory finished product is easy and quick for installation, significantly cutting the overall cost.

10 Green

Zipper connection and special double-layer sealing technique contribute to lower air leakage with less energy consumption. By utilizing environmental-friendly material plus quick dismantle and easy storage, Insusox® is a reusable product with low carbon property.

10 Visual pleasing

Multiple colors are provided to blend well with any interior decoration. Individually-customized design and fabrication are available to offer flexible and considerate service.

10 More quiet

Given the flexible material and low inner air velocity, Insusox® does not generate or transmit any resonance. Meanwhile, the insulation layer absorbs machine noise providing more quiet environment.

10 Longer life cycle

Insulated material presents superior strength, good impact resistance, and better anti-abrasion property. Meanwhile, the pressure tolerance of flexible round duct reaches 3000pa.

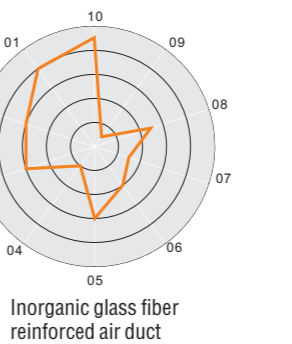
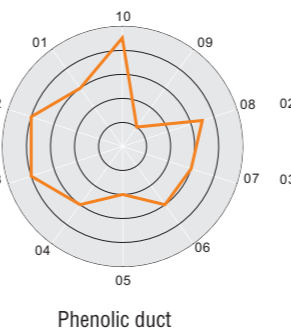
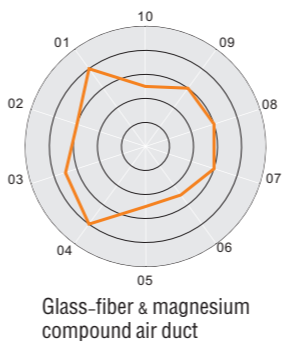
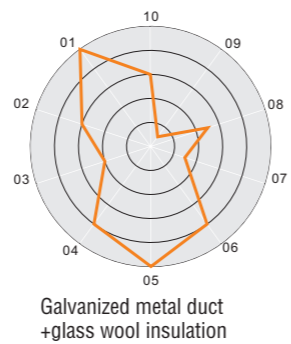
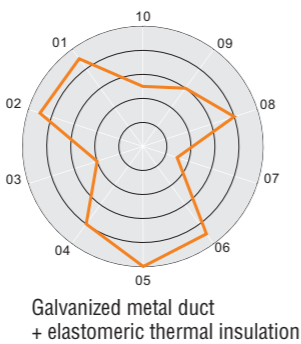

Permanant fire retardant pre-insulated fabric duct system

IN series is a perfect integration of the third generation of heating insulation made from ACMF(Accurate Control Micro-cellular Foam) as insulation layer and permanent fire retardant NanoSox fabric as surface by the exclusively-owned patented composite technology. Function layer varies from different demand, presenting excellent impact and pressure resistance, low frictional resistance, superior flexibility, anti-microbial and noise reduction property. The application covers all HVAC fields, possessing multiple international and domestic certification & patents.



PHYSICAL PARAMETER

Property Items		Index	Results	Code compliance
Material Property	Fire safety	B/S1/d0/t0 Class1&Class0	B1(B-s2,d0,t0)	GB 8624-2012 EN13501-1:2007 UL 2518 BS 476-6,7:1997
	Thermal conductivity W/(m.k)	≤0.034 (average temperature: -20℃)	0.030	GB/T 17794-2008 ASTM C177/C518-10
		≤0.036 (average temperature: 0℃)	0.031	
		≤0.041 (average temperature: 40℃)	0.036	
	Moisture resistance factor	≥1.5×10 ³	1.8×10 ⁴	ASTM E96-10
	Tear strength(N)	≥25	32.22	GB/T 17794-2008
Water absorption (by volume)	≤10	5	ASTM C209-07	
Absolute roughness of low friction resistance lining(mm)	≤0.2	0.15	GB/T 1031-2009	
Product performance	Pressure resistance & deformation	Under the pressure of 3000pa, there is no crack or breakage at the joint or other connection	No change	AC 167& UL 181
	Air leakage volume (m ³ /h.m ²)	≤1.125 (ESP:600pa)	0.97	JGT 258-2009
		≤1.355 (ESP:800pa)	1.08	
		≤1.57 (ESP:1000pa)	1.34	
		≤1.765 (ESP:1200pa)	1.49	
	Anti-condensation	There is no condensation at duct surface or zipper connection after 2 hours anti-condensation test (supply air temperature is 7-9℃, the ambient temperature is 30℃, RH80%, inner air velocity 8m/s)	Condensation free	
	Noxious gas concentration(mg/m ³)	Formaldehyde≤0.08	0.002	
		Benzene≤0.09	0	
Ammonia≤0.2		0.023		
TVOC≤0.5		0.219		

1. Shape and diameter selection



Diameter selection									
inch	8	12	16	20	24	28	32	36	40
	44	48	52	56	60	64	68	72	76
mm	203	305	406	508	610	711	813	914	1016
	1118	1219	1321	1422	1524	1626	1727	1829	1930

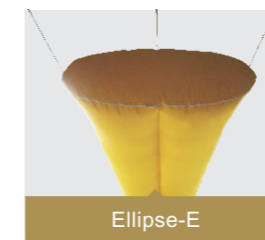

Diameter selection										
inch	12*40	12*60	16*40	16*60	16*80	20*40	20*60	20*80	20*100	24*60
	24*80	24*100	24*120	28*60	28*80	28*100	28*120	32*80	32*100	32*120
mm	305*1016	305*1524	406*1016	406*1524	406*2032	508*1016	508*1524	508*2032	508*2540	610*1524
	610*2032	610*2540	610*3048	711*1524	711*2032	711*2540	711*3048	813*2032	813*2540	813*3048

Note: 1.To decrease the resistance of air flow, the tolerance between minor axial and major axis should be smaller than 4mm. 2.Special diameters can be customized.

2. Color selection



3. Thickness of Elastic thermal insulation material

inch	1/4"	3/8"	1/2"	3/4"	1"
mm	6mm	9mm	13mm	19mm	25mm

Note: customized thickness is available according to requirement

4. Functional layer selection



IN/General
General hygienic surface effectively isolate water vapor and completely prevent fiber shedding, providing optimum heating insulation performance.



IN-M/Anti-microbial
The internal lining contains anti-microbial fiber, effectively restraining bacteria growth to create better hygienic and healthy environment for air dispersion. main applications are food and pharmaceutical industry with high hygienic standard.



IN-S/Anti-static
The internal lining contains anti-microbial fiber, effectively restraining bacteria growth to create better hygienic and healthy environment for air dispersion. main applications are food and pharmaceutical industry with high hygienic standard.



IN-N/Noise reduction
The internal lining presents noise reduction property to effectively absorb the mechanical noise and bring quiet indoor environment. Main applications are conference hall, auditorium, business center with high requirement of acoustic effect.

Nonflammable pre-insulated fabric duct system

IF series is a perfect integration of excellent inorganic non-flammable heating insulation felt as insulation layer and permanent non-flammable FiberSox fabric as surface by the exclusively-owned patented composite technology. Function layer varies from different demand, presenting extremely strong heating and sound insulation performance, completely non-flammable property, extremely low water absorption, excellent strength, superior flexibility, impact and corrosion resistance, anti-microbial and noise reduction property.



PHYSICAL PARAMETER

Property Items		Index	Results	Code compliance
Material Property	Fire safety	Class A nonflammable	Class A nonflammable A2-s1/d0/t0 Class A2&Class A1	GB 8624-2012 EN13501-1:2007 BS 476-6,7:1997
	Thermal conductivity W/(m.k)	≤0.033 (average temperature: 25℃)	0.031	GB/T 17795-2008 ASTM C177/C518-10
	Thermal resistance (m ² .K)/W	≥0.72 (average temperature: 25℃)	0.86	
	Water absorption(%)	≤5	1.5	GB/T 17795-2008
	Moisture hydrophobicity(%)	≥98	99	
	Acoustic absorption		≥0.5 (250hz)	0.812
		≥0.5 (500hz)	0.846	
		≥0.5 (1000hz)	0.932	
		≥0.5 (2000hz)	0.956	
Product performance	Pressure resistance & deformation	Under the pressure of 3000pa, there is no crack or breakage at the joint or other connection	No change	
	Air leakage volume (m ³ /h.m ²)	≤1.125 (ESP:600pa)	0.95	JC/T 258-2009
		≤1.355 (ESP:800pa)	1.01	
		≤1.57 (ESP:1000pa)	1.29	
		≤1.765 (ESP:1200pa)	1.43	
	Formaldehyde≤0.08	0.05		
	Noxious gas concentration(mg/m ³)	Benzene≤0.09	0.003	
		Ammonia≤0.2	0	
		TVOC≤0.5	0.011	
	Anti-condensation	There is no condensation at duct surface or zipper connection after 2 hours anti-condensation test (supply air temperature is 7-9℃, the ambient temperature is 30℃, RH80%, inner air velocity 8m/s)	Condensation free	
Fiber shedding	There is no fiber shedding with inner air velocity more than 15m/s	No shedding		

1. Shape and diameter selection

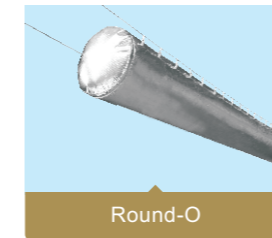

		Diameter selection								
inch		8	12	16	20	24	28	32	36	40
		44	48	52	56	60	64	68	72	76
mm		203	305	406	508	610	711	813	914	1016
		1118	1219	1321	1422	1524	1626	1727	1829	1930



		Diameter selection									
inch		12*40	12*60	16*40	16*60	16*80	20*40	20*60	20*80	20*100	24*60
		24*80	24*100	24*120	28*60	28*80	28*100	28*120	32*80	32*100	32*120
mm		305*1016	305*1524	406*1016	406*1524	406*2032	508*1016	508*1524	508*2032	508*2540	610*1524
		610*2032	610*2540	610*3048	711*1524	711*2032	711*2540	711*3048	813*2032	813*2540	813*3048

Note: 1.To decrease the resistance of air flow, the tolerance between minor axial and major axis should be smaller than 4mm. 2.Special diameters can be customized.

2. Color selection



3. Thickness selection of insulation material

inch	1/5"	2/5"	3/5"	4/5"	1"
mm	5mm	10mm	15mm	20mm	25mm

Note: customized thickness is available according to requirement

4. Functional layer selection



IF/General
General hygienic surface effectively isolate water vapor and completely prevent fiber shedding, providing optimum heating insulation performance.



IF-M/Anti-microbial
The internal lining contains anti-microbial fiber, effectively restraining bacteria growth to create better hygienic and healthy environment for air dispersion. main applications are food and pharmaceutical industry with high hygienic standard.



IF-S/Anti-static
The internal lining contains anti-microbial fiber, effectively restraining bacteria growth to create better hygienic and healthy environment for air dispersion. main applications are food and pharmaceutical industry with high hygienic standard.



IF-N/Noise reduction
The internal lining presents noise reduction property to effectively absorb the mechanical noise and bring quiet indoor environment. Main applications are conference hall, auditorium, business center with high requirement of acoustic effect.

FITTING & COMPONENT

Insusox® air duct consists of a variety of fittings and component, it can be applied into all air duct fields of A/C system, including the trunk, branch duct, inlet, air damper, end cap, internal components, air vents, air dispersion duct and air return duct, etc.

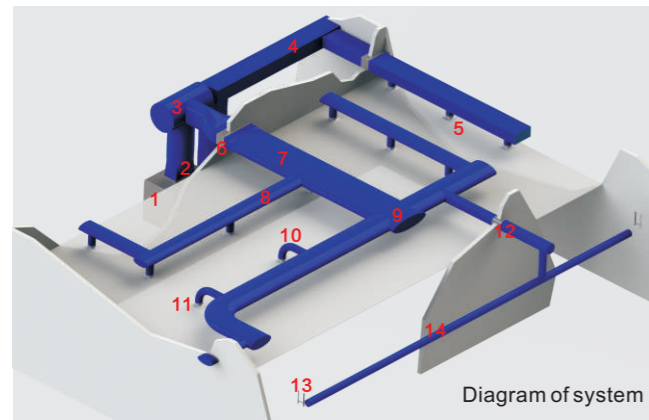

- 1 AHU
- 2 Inlet
- 3 Fabric plenum
- 4 Return air duct
- 5 Return air grille
- 6 Fire damper
- 7 Ellipse main duct
- 8 Ellipse branch duct
- 9 T-connector
- 10 Elbow
- 11 Diffuser
- 12 Wall pass through
- 13 Cable suspension system
- 14 Air dispersion duct

Fitting

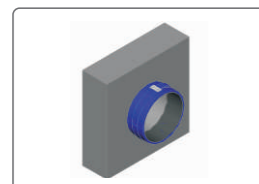

Inlet connection
Connect with metal outlet, quickly fix by special fastener, easy dismantle.

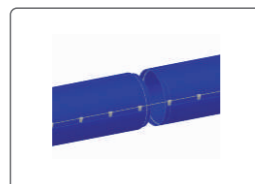

Zipper connection
Fittings are connected via zippers. patented double-sealing technology is used to prevent air leakage.

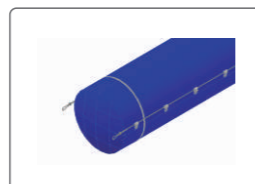

End cap
Connect with duct via zipper.

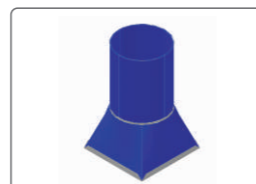

Fabric diffuser
Connect with metal outlet, quickly fix by special fastener, easy dismantle.

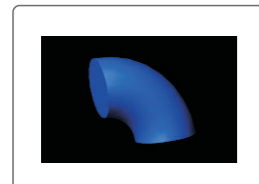

Elbow
Center-line radius is 1.5 times of diameter

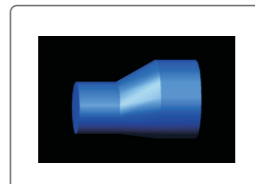

Transition
For connection of duct with different diameter

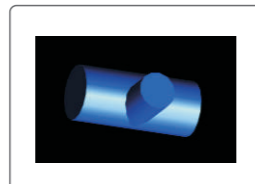

Tee
Deliver the airflow to branch duct perpendicular to main duct.



Special fittings
Y-inlet, square to round inlet, elbow inlet

Component

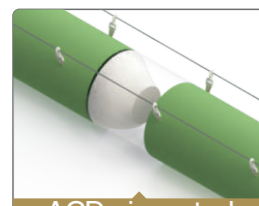

ACD (air control device)
Exclusively-patented ACD. One end connects to duct via zipper, control airflow by adjusting the openness on the other end.

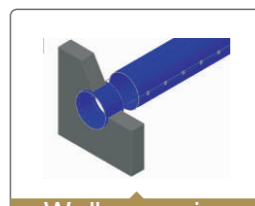

Wall acrossing section
Special rigid collar is introduced to seal the gap between the duct and the wall. connect with Insusox duct via zipper on both side.

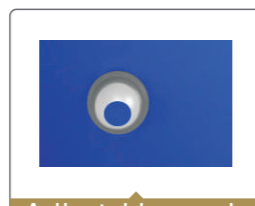

Adjustable nozzle
Exclusively patented adjustable nozzle is able to adjust air throw angle to meet demands in different application.



Fabric nozzle
Exclusively patented fabric nozzle. adjust air throw angle to meet demands in different application.

SELECTION

Diffusox®

It's a brand new fabric diffuser for applications in spaces with false ceiling.

There are plane surface and cambered surface for options. with the utilization of exclusively-owned patented technology, Diffusox® presents even air dispersion, better visual appearance and easy maintenance.



Certainly, Insusox® is able to co-work with traditional metal diffuser as well.

Durkeesox® fabric duct

In the large and high space without ceiling, Durkeesox® fabric duct is the optimum option.

DurkeeSox® fabric air duct utilize PFPC (Precise Fabric Permeability Control) technology to match and cooperate with A/C system via accurate fabric permeability calculation and precisely-designed orifices. It's a flexible air dispersion end system replacing traditional air dispersion duct, air outlet and insulation material, which we call fabric air dispersion system.



Returnsox®

Made of high-strength nano-alloy material, ReturnSox® utilize exclusively-owned patented internal support frame to maintain the flexible air duct in rectangle shape and return air under negative pressure, matching with air vents and air dampers and replacing traditional return air duct with on-site cable suspension.

High strength, visual pleasing, light weight, easy and quick installation as finished product, the exclusively-owned patented support frame effectively withstands the negative pressure inside flexible fabric air duct and fulfill the demand of air return and air exhaust.



SELECTION SYSTEM DESIGN

The system design of Insusox® is similar with traditional fabric air dispersion duct. Designers can make layout design according to DurkeesoX® design guidance manual or patented Isox-design software.

A. System layout

Insusox® is mainly used for air delivery duct system in HVAC industry. Layout design of Insusox® pre-insulated fabric duct system is created according to the location of AHU and height of space in the construction drawing, as well as requirement on aesthetic effect and air dispersion area.

I-sox design software contributes to make the layout design effectively, saving considerable time.

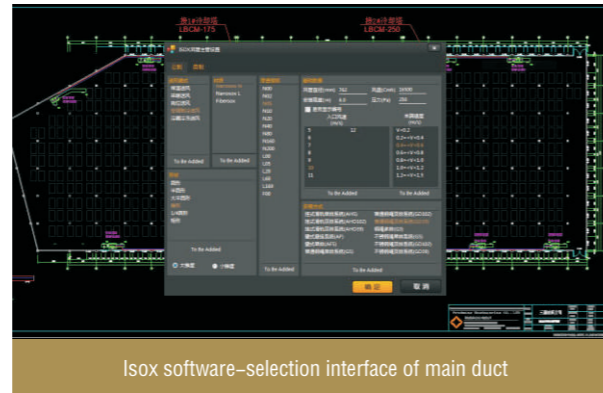

Duct design in machine room

Traditional plenum or DurkeeSox® patented noise-proofing fabric plenum is designed based on the surroundings at site or customer's requirement. Insusox® duct connects with AHU or plenum directly. As for the application crossing fire compartment, Insusox® is connected with FRD by patented inlet effectively; For crossing-wall application, Insusox® can pass through the wall with DurkeeSox® crossing-wall section.

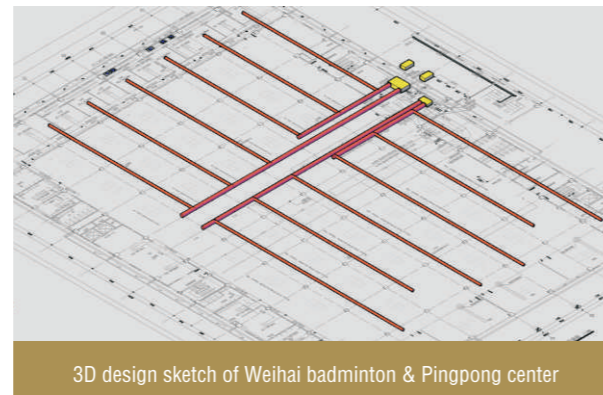

Main duct design

Straight duct shall prevail in main duct design, the design is simple and rational while reducing the on-way resistance and noise.

—Application with false ceiling, the main concern is the space height and other structural conflict and barriers. the layout of main duct shall be parallel along walls, beams, pillar and ceiling poles.

—Application with open ceiling, except the concerns of space height and structural conflicts and barriers, the circumvention to devices, vehicles, water pipes, and bridges and other obstacles as well as aesthetic factor should be taken into concern.

Air damper and air outlet design

As same as traditional metal duct, ACD (airflow control device) is designed for Insusox®, the fabric airflow control device can connect with Insusox® via Zipper.

— Application with false ceiling, Insusox® duct is able to connect with traditional duct by air inlet or with Diffusox® by zipper.

— Application with open ceiling, Insusox® is able to connect with DurkeeSox® duct directly by zipper to obtain even air supply.

The layout of Diffusox® should be as even as possible with consideration of rational co-work with return airflow to improve the indoor airflow system.

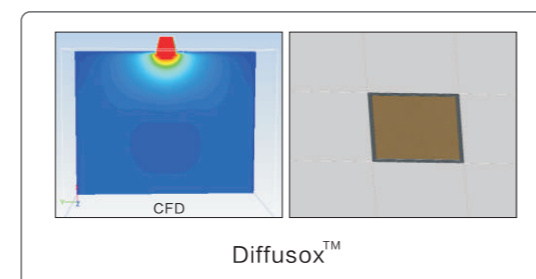

B. Dimension selection of Insusox®

The diameter selection of Insusox® is related to Inner air velocity.
Calculation formula: $G=3600V \cdot n \cdot D^2/4$
Insusox® use inch as units, 12-80(305-2031mm), 4 inches per one interval.

The design of inner air velocity should take air dispersion resistance and noise into consideration: the higher the inner air velocity, the larger the inner air resistance. resulting in larger amount of power consumption and noise.

Base on lots of project cases and test data, the following inner air velocity is provided for design reference:

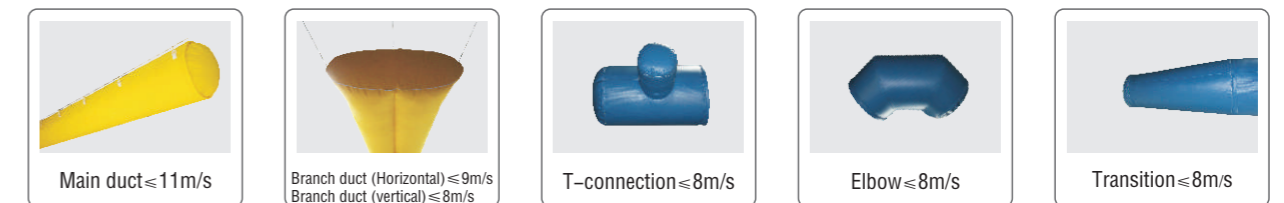

C Air supply pressure calculation

The internal pressure of Insusox® duct consists of static pressure, velocity pressure and on-way pressure loss, among which the relation between static pressure regain and on-way pressure loss plays a major role. In most circumstances, Inner pressure of straight Insusox® plus static pressure regain is larger than on-way pressure loss value.

Inner pressure at endcap = inner pressure at inlet + static pressure regain - on-way resistance loss

In view of rich project experience, when the proportion of pressure difference to inlet static pressure is less than 10%, we can approximately consider that the discharge airflow is evenly distributed along the lengthwise direction of InsuSox system. If the proportion is exceeded, a PAD is required to balance static pressure in whole duct.

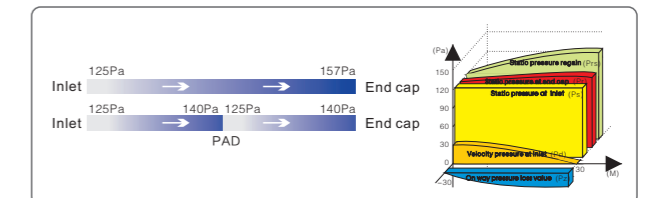

D. Insulation thickness design

Given the excellent thermal insulation performance of Insusox® texture, it is not necessary to consider permeability in design phase. To control the cost and energy loss and effectively avoid the condensation, it is required to select the thickness of thermal insulation materials. Since thermal insulation for cooling air condition is thicker than that for heating air condition, while cooling insulation has large impact on A/C system, the thickness of cooling insulation shall prevail in the design. After the thickness of cooling insulation is calculated in economical manner, the thickness of composite insulated layer is finally decided as a closest calculated thickness in view of the Insusox® wall thickness.

Calculation for economical thickness:

Economical thickness is the minimum heating insulation thickness equivalent to a sum between annual heating or cooling loss value and annual depreciation value of insulation investment. generally speaking, the shape of duct system is round or ellipse. To calculate the thickness of thermal insulation material, please refer to the formula below:

$$(d+2\delta) / (n(d+2\delta) / d) = 2A \sqrt{(\lambda \cdot \tau \cdot fn(tg\omega - tgn) / \pi \cdot S) - 2\lambda / \alpha gw}$$

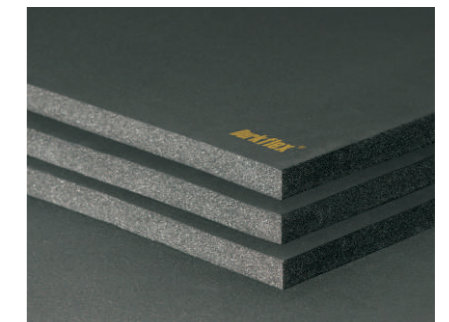

INSTALLATION

Insusox® integrate and streamline its production procedures in the factory, leaving the installation work that on-site worker can easily manage well. That contributes to easier installation, lower cost and shorter construction time compared with that of traditional air duct.

A. Installation type

Insusox® is installed by cable suspension, simple and quick.

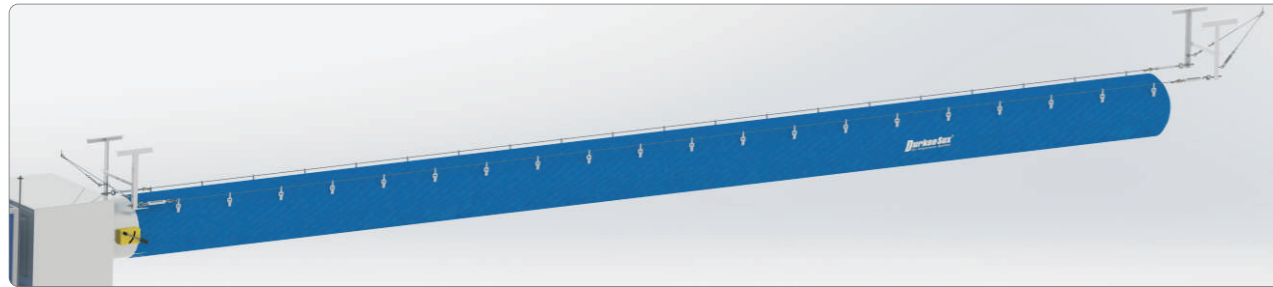

The installation of Insusox® pre-insulated fabric duct system varies from the cross-section shape.:

1. In view of the diameter, there are two types of installation: double-row (3:00 & 9:00) and triple-row (12:00, 3:00, 9:00).

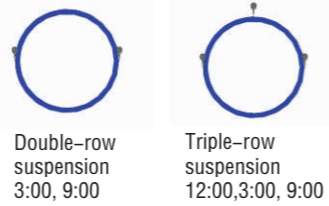

2. Ellipse duct use multi-row suspension method with DurkeeSox® exclusively-owned patented pulling cable technology, effectively reducing the height of duct itself while ensuring visual pleasing.



3. Returnsox® use quadruple cable suspension system and DurkeeSox® exclusive & patented NIR supporting technology to maintain the flexible air duct in rectangle shape and return air under negative pressure.



B. Installation procedure

1. Locating and routing of bracket

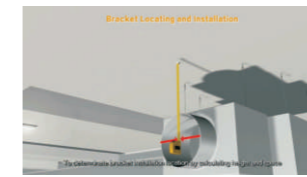

Locating the height of bracket



Locating the spacing of bracket

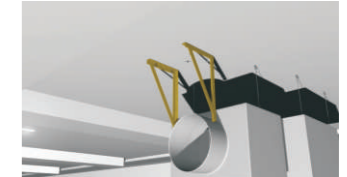

Install the bracket

2. Installation of cable system



Cable measurement & cutting and connection with bracket

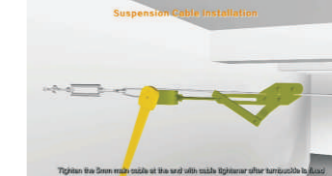

Tighten the cable from both side



Installation of hanging points

3. Inlet installation

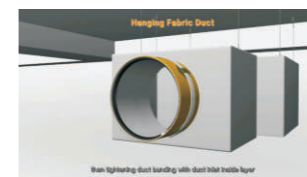

Inlet connection and fixing

4. Hanging duct

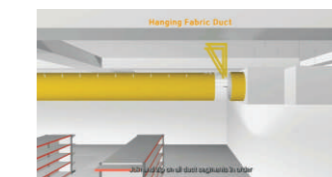

Connect the inlet with the first segments of duct



Connect all segments

5. Ventilation and suspension adjustment



Straighten and adjust the duct



Ventilation for adjustment

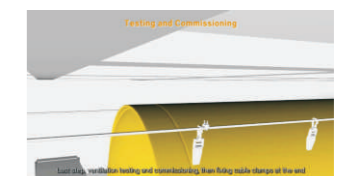

Fix the cable end clamp

APPLICATION / CASE STUDY

Insusox® applications in machinery workshop, electronics factory and food factory.

Insusox® Application in Isuzu.

Founded in 2013, Isuzu is a joint venture company with a focus on manufacturing its latest type of pickup and SUV. Given the limited roof load bearing capacity, relatively low cooling capacity and airflow supply, the design proposal with Insusox® pre-insulated fabric duct and DurkeeSox® air duct was approved by the Owner to obtain secondary air supply. The first air supply system (air delivery duct) is installed at the height of 7-9m, connecting with secondary air supply system (air dispersion duct) at 2-3 meter right above the post line via vertical duct. Orifices are designed along the exact location of working post to throw limited cooling airflow towards the posts, fully demonstrating its superiorities of energy conservation, comfortable and even air dispersion, visual pleasing, low requirement of roof loading capacity and etc.



Insusox® applications in commercial center, professional wholesale center, retail market and supermarket

Insusox® Application in Aushan (Nantong store, Jiangshu province)

Auchan group was founded in 1961 in the northern French city of Lille. It is the 2nd largest retail distribution in France, as well as a member of the Fortune 500 companies. With a focus on hypermarket, supermarket and convenience stores, Auchan group started new business in processing and financing sector. By the end of 2006, Auchan has owned 16 hypermarkets. In 2007, Auchan speed up its business development, providing services to thousands of Chinese consumers and winning great popularity and recognition among them. Auchan applied DurkeeSox® air duct in shopping area whereas Insusox® inside false ceiling area, contributing to energy conservation, condensation free, and even and comfortable air dispersion.

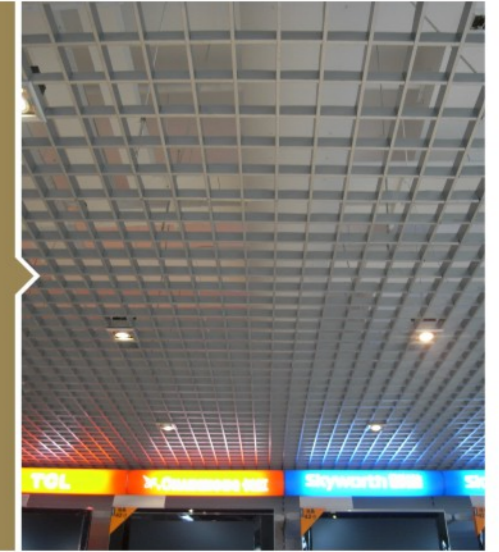

Insusox® Application in LM Wind Power

As a global market leader in manufacturing the wind power blade, LM wind power has established its own factory in Denmark, Poland, Spain, America, India, Canada and China with headquarter in Netherland. Established in 2001, LM (China) sets up the headquarter in Beijing and 4 factories in 4 prosperous cities, Tianjing, Xingjiang, Qinghuangdao and Jiangying with over 1000 employees, engaged in supplying fan blade to wind power industry in Chinese and Asian market.

Insusox® application into LM factory brings no temperature difference along the fabric air duct, reduce the energy consumption while obtaining even and comfortable air dispersion.



Insusox® Application in badminton & table tennis center (Weihai city, Shandong province)

As a large-scale table tennis and badminton training center, Weihai Sports Center has a table tennis stadium with area of 5500 square meters and a badminton stadium with area of 5300 square meter, accommodating 300 people for training. Traditional air duct discharge air via dozens of air outlets, bringing uneven and uncomfortable air dispersion. Besides, the high terminal air velocity might change the motion trail, affecting training and match. Insusox™ is designed for air delivery to work with DurkeeSox® air dispersion system. In daily design, Insusox is designed as main duct while DurkeeSox® serves as branch duct to discharge air via orifices along the duct. Even though the air throw distance amounts to 80m, the system brings even and comfortable air dispersion without any temperature difference. All cooling capacity and airflow are evenly distributed into sports center via orifices along the duct, fulfilling the air dispersion standards of international table-tennis and badminton match field.

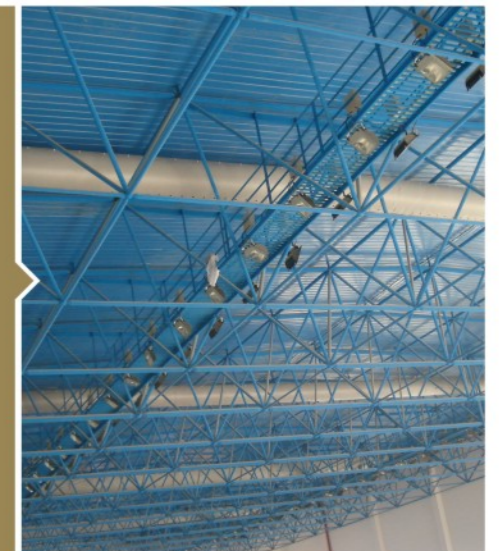

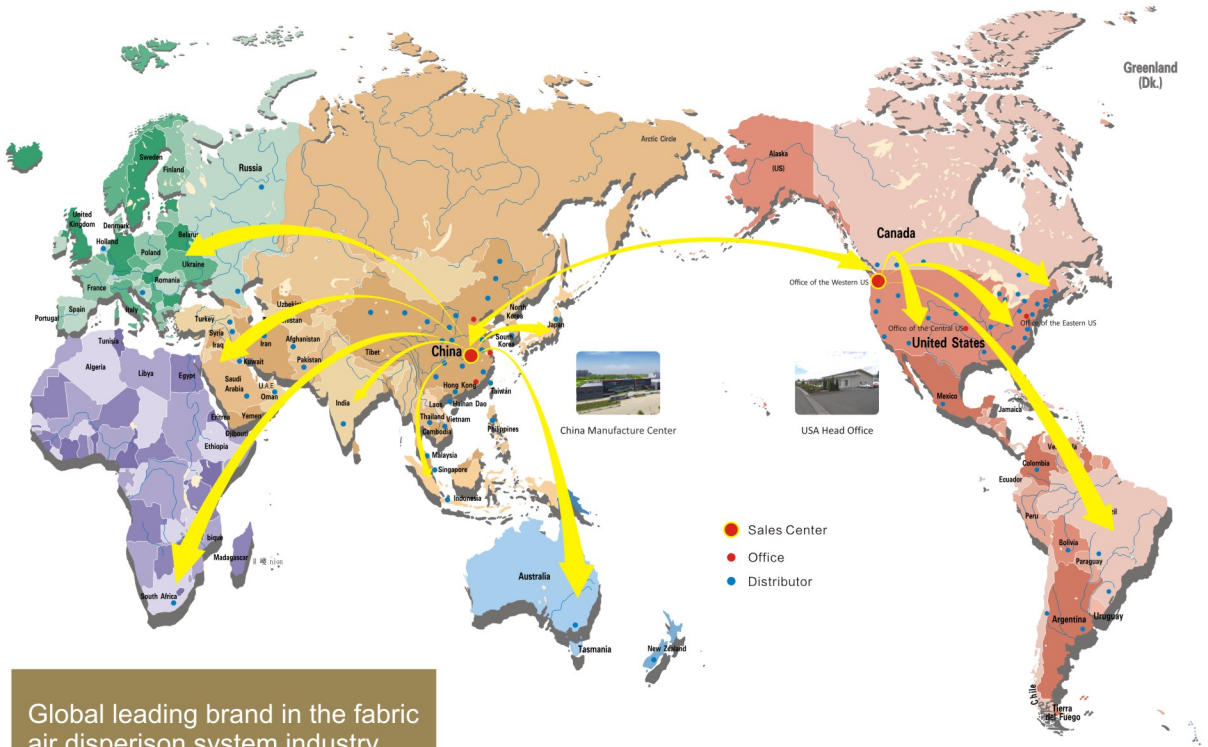

Global leading brand in the fabric air dispersion system industry

DURKEE INDUSTRIAL PARK

Durkeesox[®] was invested and established by US registered Durkee International Industry Ltd. It's a multinational high—tech enterprise, focusing on developing air dispersion system in HVAC/R industry. As a manufacturing & servicing oriented organization, Durkeesox[®] has established two manufacturing centers (China and USA) and 3 sales and service centers (China, Asia and America). Being a member of USGBC, it has been one of the fastest growing and largest fabric air dispersion system supplier in the industry with leading brand in global market.

[Patent production specification]

All rights of Insusox[®] pre-insulated fabric duct and related product are reserved by Durkeesox. Any counterfeit or sales by any entity or individual is strictly prohibited, otherwise, Durkeesox shall ascertain its legal responsibility accordingly.

HOTLINE FOR SERVICE
400-882-2068
www.durkeesox.com

DURKEESOX (WUHAN) AIR DISPERSION SYSTEM CO.,LTD
ASIAN SALES CENTER

8# West Ren Min Rd. Gedian Economic Development Zone,
Ezhou Hubei, China, 436070.
Tel: 86-27-59370099 Fax: 86-27-59370098
Email: sox@durkeesox.com

HOTLINE FOR SERVICE
(206) 639-2889
www.nanosox.net

DURKEE AMERICA, INC.

PO BOX 1592
Issaquah WA 98027
Tel: 1(206)639-2889 Fax: 1(206)639-2890
E-mail: info@durkeintl.com

Durkeesox[®] Insusox[™] and other trademarks or word marks are all owned by Durkee International . All the photos are owned by the company. The information mentioned in this article is subject to print, there maybe modification to the product by the company which may not be in it. The company reserves the right to change product design and specification. There may be differences between photo and product, the color and appearance of the actual product shall prevail.